

Key Menu Functions

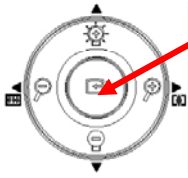

The **MENU button** is located in the center of the control panel wheel. Pressing this button allows the user to access the menu selection for adjustment of output settings, image adjustments, macro as well as microscope modes, screen capture settings, preset functions, and more.

VGA Output with the Promethean 95" Interactive Whiteboard

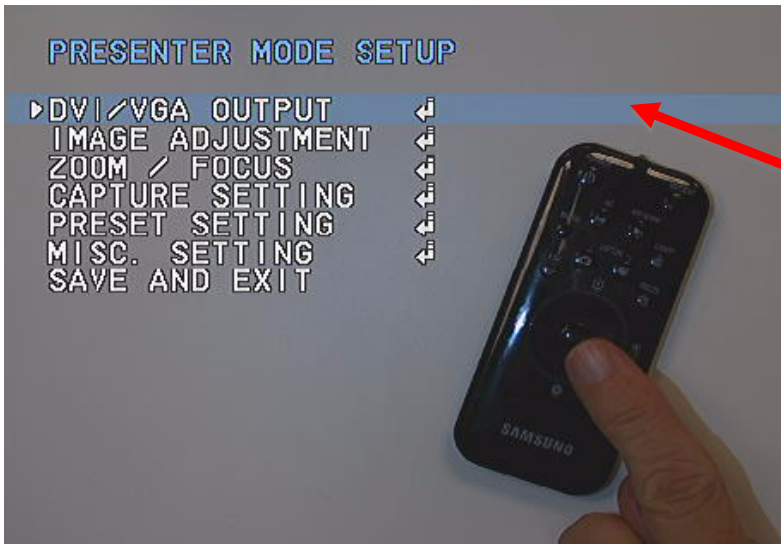

1) Press the **Menu button** on the 860 Panel or as shown here on the middle of the remote control.

2) The **DVI/VGA OUPUT** menu is at top of the list and already highlighted in blue. Press the Menu Button a second time to bring up the next menu.

3) By **default** the unit is set at SXGA 1280 X 1024 4:3

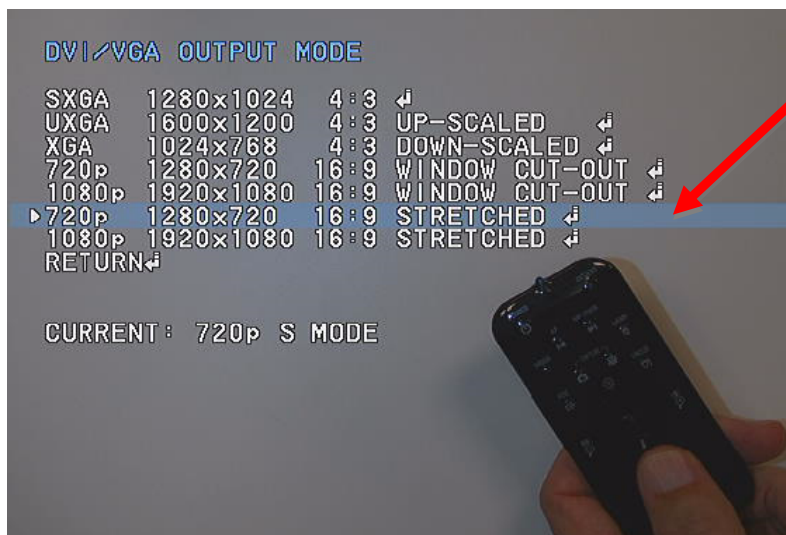

4) Using the DOWN button on the Menu Wheel, scroll down to **720p 1280 x720 19:9 STRETCHED**

5) Now click on the center Menu button again.

6) A new menu will appear and ask you to 'Keep these settings?' Scroll down and select '**Yes, I want to keep these settings**'

Keep these settings?

No , I want to revert previous settings. ⏪
▶Yes, I want to keep these settings. ⏪

Image Adjustment - Rotate 0° and 180°

As mentioned at the beginning of the guide, doc cams are placed in either the top left or right corner of the Presentation Station table.

Note - The rationale for putting the doc cam in one of the corners is to maximize the space on the table. For year one i21 teachers, your table has one hole drilled left of center on the table. We have advised all installers not to secure the doc cam in this location with the security screw. For the most part, teachers hate this location as it takes up most of the table. If an installer has secured the doc cam to the table, please work with your BSS to get the doc cam unscrewed so that you can put it in one of the corners.

Choosing the left or right side is determined by where the table itself is positioned in relation to the Promethean Board.

- Place the document camera on the side furthest away from the Promethean board.

Left Side of Table



- If you have placed the doc cam in the left hand corner of the table, the doc cam lens will be turned so that the camera lens itself is to the right of the base. See the picture here. This allows the camera head to be positioned on the presentation station table and provides room to place documents and object underneath.

In relation to [Image Adjustment on the Menu](#) – This setting is **Rotation 0°**.

By default the camera is set at Rotation 0°, so you don't need to make any adjustments!

Right side of Table

- If on the other hand, you have placed the doc cam in the right hand corner of the table, the doc cam lens will be turned so that the camera lens itself is to the left of the base. See the picture here.

In relation to [Image Adjustment on the Menu](#) – This setting is **Rotation 180°**

By default the camera is set at Rotation 0%, so you will need to make the following adjustments:



When Doc Cam is Positioned on the Right Side of the Table

- 1) As you can see, if the document camera were placed in the right corner of the Presentation Station table with the **default setting - lens head on right side of doc cam base**, the camera head would be off the table!



- 2) To remedy this situation, rotate the camera head by swinging it down and around (clockwise).



- 3) This illustration shows you have rotated the camera head 180°

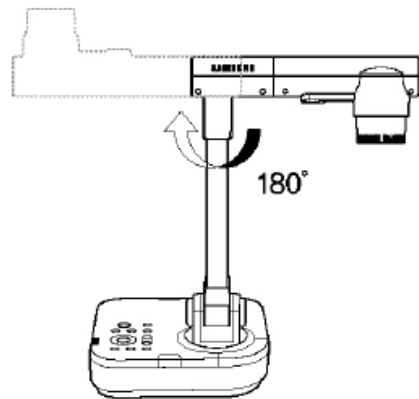

- 4) Turn the camera head around so it is facing down towards the table and now go to **Image Adjustment**.



Menu - Image Adjustment to Rotate 180°

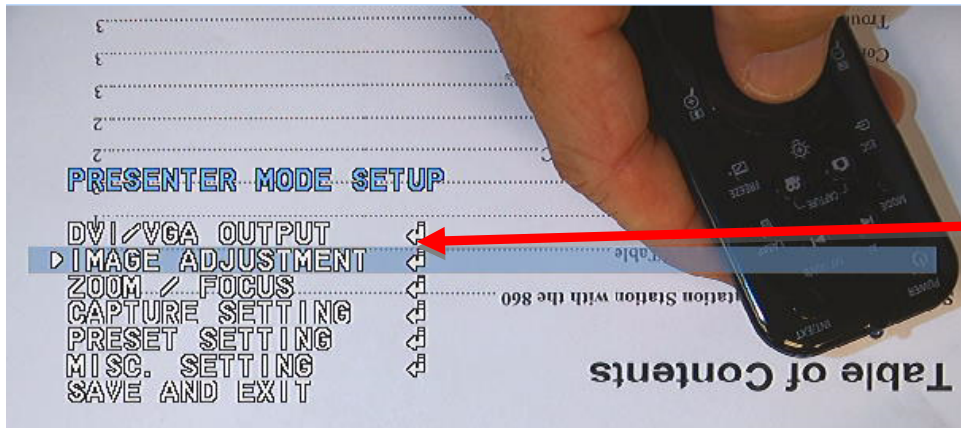

1) Press the **Menu** button on the 860 Panel or as shown here on the middle of the remote control.

2) Scroll one down to **IMAGE ADJUSTMENT**.

3) Click middle button.

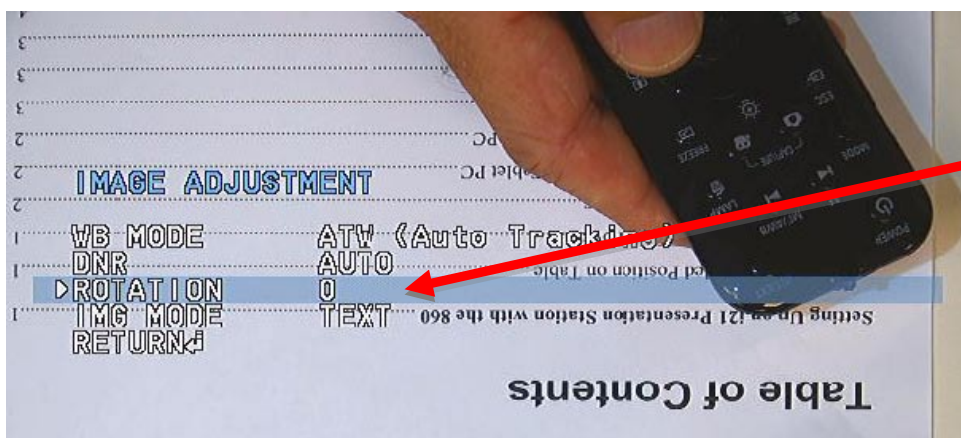

4) Using the DOWN button on the wheel, scroll down to **ROTATION 0**

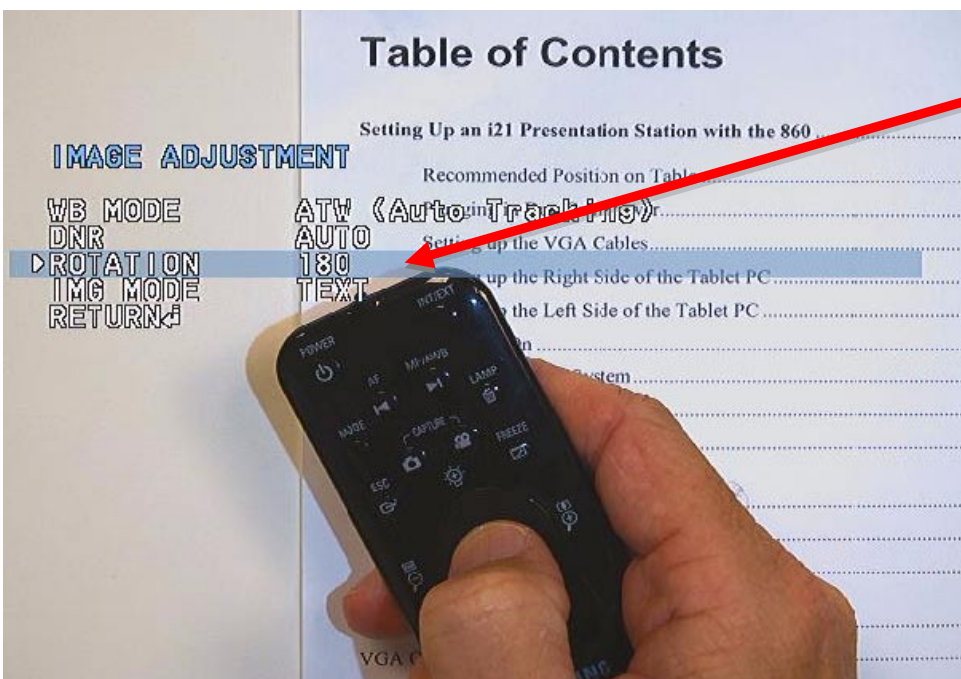

Click the **RIGHT** button on the wheel to select **180**.

5) The image will instantly switch 180°.

6) By comparing the image directly above with the image to the left, you can see the remote control and Table of Contents page move from being upside down to right side up.

7) Now scroll down, select **RETURN** – click menu button, then scroll down to **SAVE** – Click menu button.